

# FORD

## SERIES 725 LOADER

# OWNER'S MANUAL

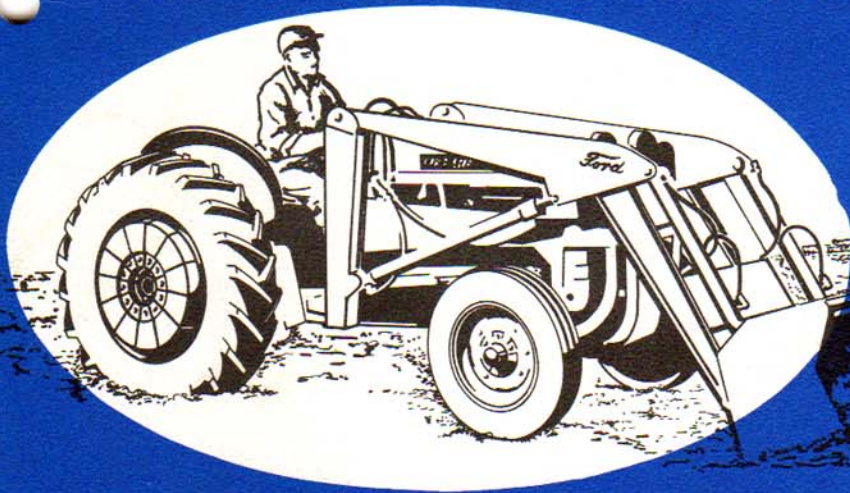

FORD TRACTOR DIVISION  
TRACTOR AND IMPLEMENT OPERATIONS (U.S.)  
FORD MOTOR COMPANY

## FOREWORD

This manual has been prepared to acquaint you with the many features of the Series 725 Loader. A series of line drawings have been provided to illustrate some important techniques of loader operation. We suggest that you study these illustrations as they will help you obtain more efficient and dependable operation from your new loader. The sections of this manual on Lubrication, Maintenance, and Storage, contain information that will help you keep your loader in good working order.

SERVICE DEPARTMENT  
TRACTOR AND IMPLEMENT OPERATIONS (U.S.)  
FORD TRACTOR DIVISION  
FORD MOTOR COMPANY

## CONTENTS

<b>OPERATION</b> .....	4
Loader Controls .....	4
Operating Techniques .....	5
Loader Operation With A Select-O-Speed .....	9
<b>SAFETY PRECAUTIONS</b> .....	9
<b>ATTACHMENTS</b> .....	10
<b>BUCKET INSTALLATION</b> .....	13
<b>LUBRICATION</b> .....	13
<b>HYDRAULIC SYSTEM MAINTENANCE</b> .....	14
<b>STORAGE</b> .....	15
<b>TROUBLE SHOOTING</b> .....	16
Loader .....	16
Hydraulic Oil Leakage .....	17
Pump .....	17
Valve .....	18
<b>SPECIFICATIONS</b> .....	19

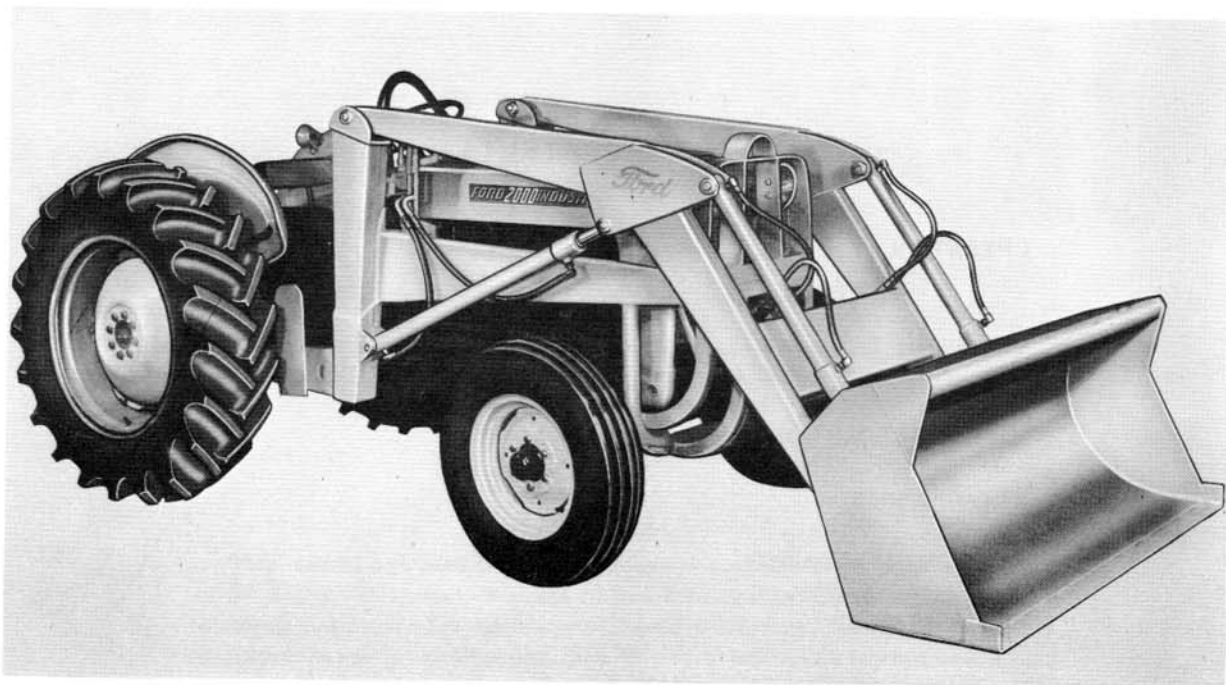

*Figure 1*  
*Series 725 Loader*

The Series 725 Ford Loader is a 1600 pound lift capacity loader. The loader is designed for use on Ford Series 2000 or 4000 Industrial Tractors and the Ford All-Purpose Tractors equipped with a heavy duty front end. The loader can be mounted on the tractor in conjunction with the Ford 10' or 12' Backhoe.

Before putting the loader in operation it is necessary to add counterweight to the rear of the tractor. An additional weight of 1600 pounds is necessary for safe operation. Obtain this weight by using rear wheel weights, liquid ballast or rear attached equipment.

The loader should be operated with the tractor engine running between 1200 and 1500 rpm. Excessive speeds are dangerous and may cause bucket spillage and unnecessary strain. When operating in temperatures below 30° F., run the tractor engine below 1200 rpm until the oil temperature rises above 30° F.

**Loader Controls:** The loader operation is controlled by two levers, Figure 2. Each lever has three positions as shown. The levers can be operated together for faster breakout and more aggressive bucket action.

The lever can be "feathered" (moved slightly) in all positions to give precise lift and bucket control.

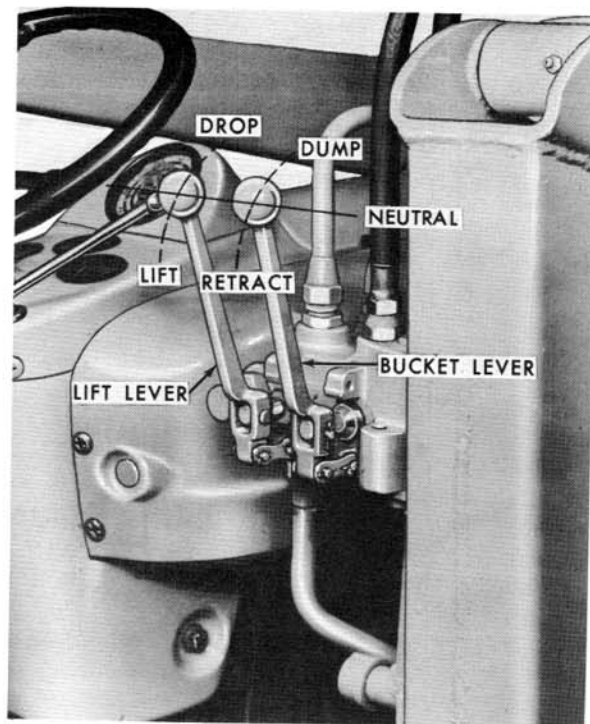
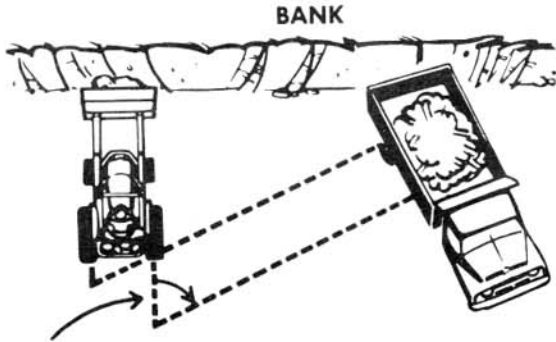

*Figure 2*  
*Loader Controls*

# OPERATION

## LOADING TRUCKS FROM A PILE OR BANK

Choose a forward gear that provides sufficient ground speed and power for loading.



For faster loading, minimize the angle of turn and length run between bank and truck.

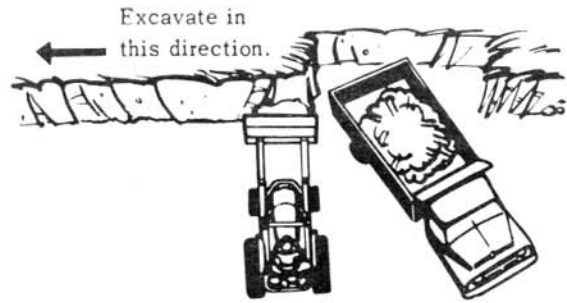
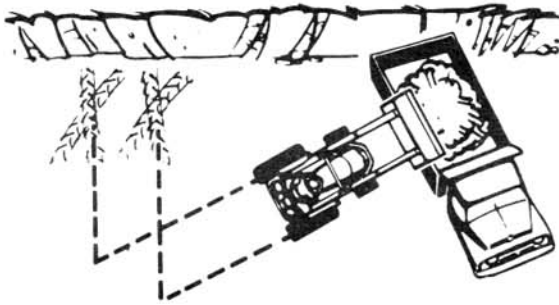

## LOADING FROM A STOCKPILE

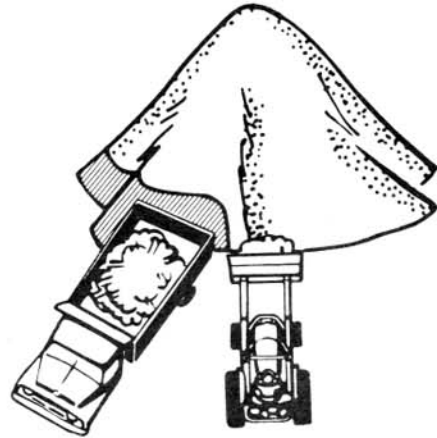

Clean an area so the truck can work in close to the loader.

Keep the working surface free of ruts and holes. Backgrade with the bucket occasionally, and approach the bank with the bucket flat. Slight down pressure with the bucket level helps keep the working area smooth. Use the heel of the bucket for backgrading ruts, etc.

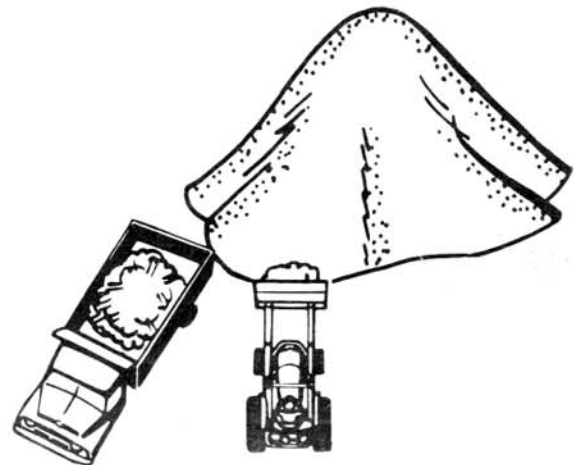
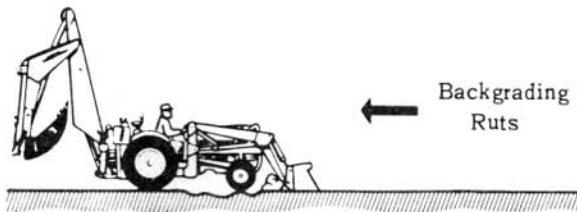

Work around the pile keeping the truck in close.

Always keep the truck close to operation and keep the excavating depth about  $\frac{2}{3}$  the length of the truck bed.

# OPERATION

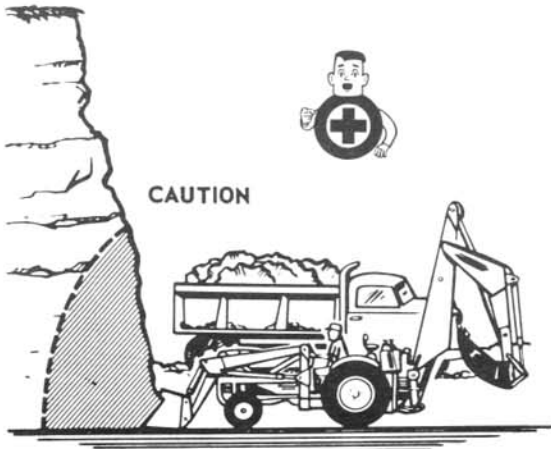

**CAUTION**

Exercise caution when undercutting high banks. Dirt slides can be dangerous. Load from as low as possible for maximum efficiency.



Sidecutting is a good technique for cutting down a big pile.

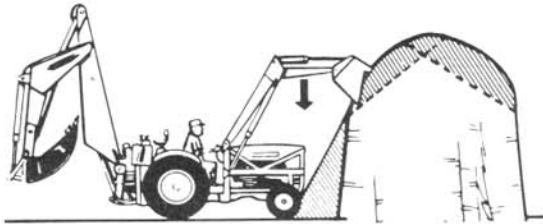

Cut away from pile sides. If pile sides are too high and liable to cave-in, use the loader to break down sides until a slot can be cut over the top.

Remember that the loader lift and break-a-way capacities diminish rapidly as loading height is increased.

## PEELING AND SCRAPING

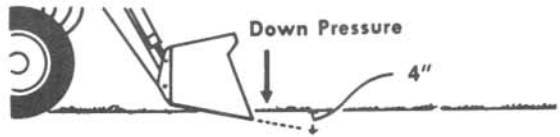

Use down pressure and a slight bucket angle to start long cuts. Make a short angle cut and break out cleanly.

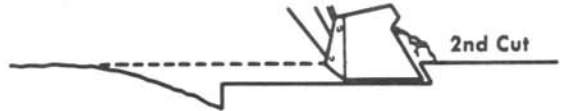

With the bucket level, start a cut at the notch approximately 2" deep. Hold the depth by feathering the bucket lever to adjust the cutting lip up or down. When the front tires enter the notch, adjust the lift cylinders to maintain proper depth.

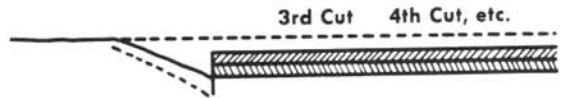

Make additional passes until the desired depth is reached.

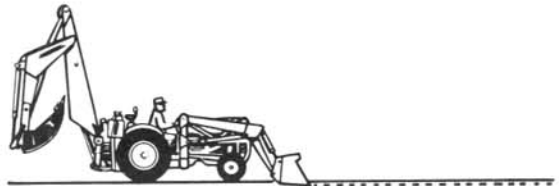

During peeling operations, use lift cylinder down pressure and a slight bucket angle to penetrate to the desired working depth. After reaching the desired working depth, only use the bucket control lever. This allows the operator to concentrate on controlling the bucket angle to maintain a precise cut.

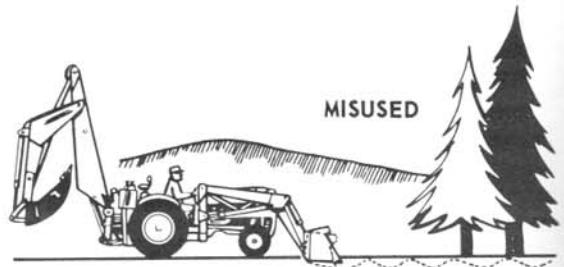

# OPERATION

If the lift control is used without controlling the bucket angle, the cut will tend to undulate and make succeeding passes difficult.

## BACKFILLING

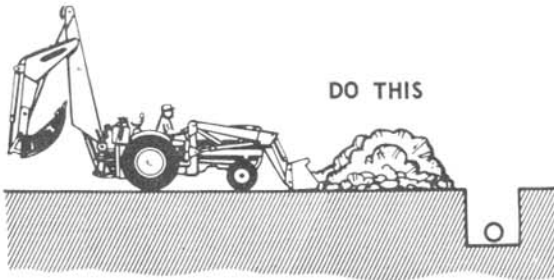

Approach the pile with a flat bucket.

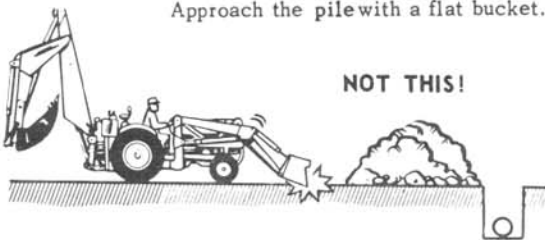

The wrong method, shown above, will impose severe shock loadings on the bucket cylinders and lip. Poor methods actually move no more dirt. In addition, the wrong method makes it more difficult to hold a level grade.

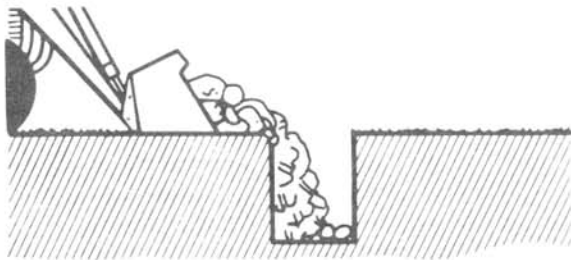

Leave dirt in the bucket because dumping on each pass wastes time.

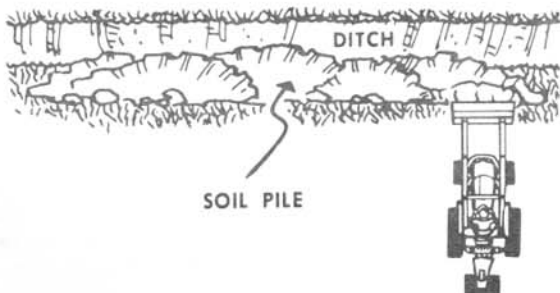

Operate at right angles to the ditch. Take as big a bite as the tractor can handle without lugging down.

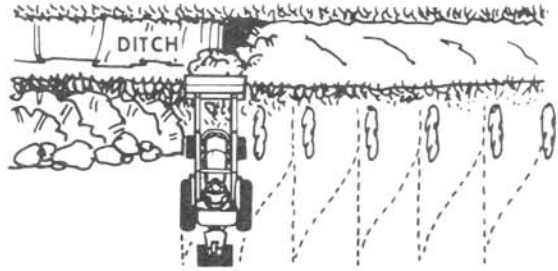

Leave dirt which drifts over the side of the bucket for final clean-up.

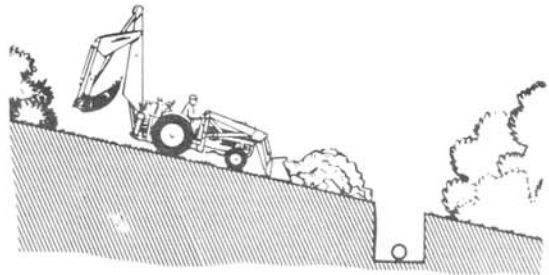

Backfilling on a slope - Have dirt piled on the high side for easier backfilling.

Efficient backfilling operation occurs when the tractor pushes the most dirt possible without losing speed or traction. If the tractor slows, the operator should raise the bucket. If not working at capacity, lower the bucket slightly. Make gradual adjustments to avoid making steps in the path of the tractor.

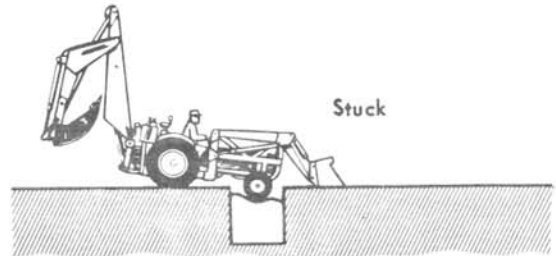

If you travel too far and get stuck in the ditch, dump the bucket and apply down pressure to lift the wheels out of the hole. Operate both loader control levers together with tractor power to move in reverse.

# OPERATION

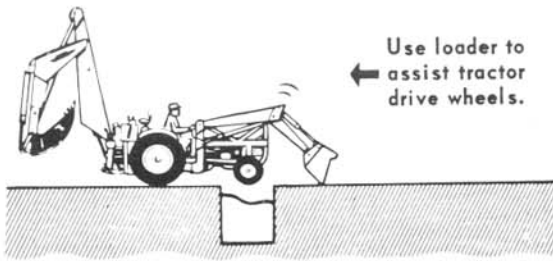

Use loader to assist tractor drive wheels.

## BREAKING AND SPREADING LARGE PILES

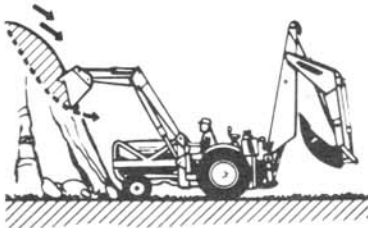

Build a ramp by shovel-loading material off the top.

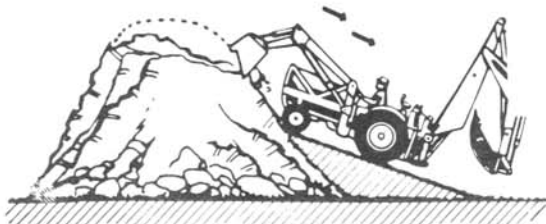

Shovel off the top, pushing towards the excavation. Drag some soil backwards to form a work ramp of convenient grade.



## LOADER BREAK-A-WAY

Come in level --



Work both levers back to direct pressure to all four cylinders.

The combined action of the lift and bucket cylinders will increase efficiency because . . .



. . . a straight bottom throughout offers more resistance to lift.

## SAFE LOADER OPERATION

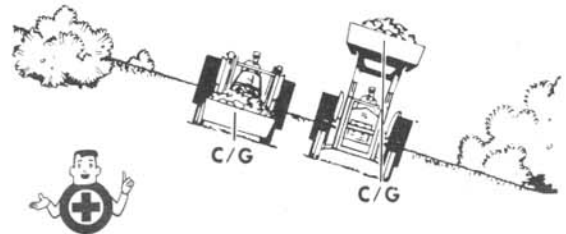

Carry the bucket low for safety.

When transporting the loader with the bucket loaded or empty, the lift arms should be raised to a height where the bucket is just below the level of the tractor hood. Good stability and visibility are obtained when the lift arms are in this position.

Keep the working floor smooth. In loading trucks, keep the bucket low as long as possible.



Maximum truck loading productivity is determined by the bucket's load and the number of trips made in a given time. However, don't lose productivity trying to get a full bucket if it means losing time backing up to hit the bank twice.



# OPERATION

## LOADER OPERATION WITH A SELECT-O-SPEED TRACTOR

The "shift-on-the-go" feature of a Ford Select-O-Speed Tractor provides an opportunity for faster and more efficient loader operation. However, in order to take advantage of Select-O-Speed, it is necessary to understand and practice the technique of "shuttle shifting."

The following procedure outlines a loader operation using "shuttle shifting."

1. Install the selector lever and neutral bypass plate on the left side of the selector mechanism. See the operation section of your tractor owner's manual for instructions on relocating the selector lever.

**NOTE:** The bypass plate with installation instructions is enclosed with the tractor owner's manual.

2. Install speed stop screws on the bypass plate to limit the lever travel between 5th and R<sub>2</sub>.

3. Start forward in 5th gear using the foot throttle to increase tractor speed. Keep your right hand on the loader controls, and after establishing direction, keep your left hand on the selector lever.
4. Just as the bucket hits the pile, downshift to a lower gear to maintain engine rpm and power. This is important because engine rpm keeps the loader hydraulic pump operating at capacity.
5. Pull both loader controls to pry and lift with bucket. Note the graphic illustrations on loader break-a-way in the operation section.
6. When the bucket is loaded, depress the inching pedal and snap the selector down to reverse. Ease up on the pedal to back out.
7. Only back far enough to make an easy swing to the truck. Then, depress the inching pedal and snap the lever back against the 5th speed stop. Stop the tractor, using brakes, and release the inching pedal to start forward travel.



## SAFETY PRECAUTIONS

Do not allow anyone but the operator to ride on the tractor-loader.

Do not make mechanical adjustments while the unit is in motion.

Do not attempt to repair or tighten hydraulic hoses when under pressure, when the tractor engine is running, or when the lift arms are raised.

Do not dismount from the tractor and leave the loader lift arms raised.

Do not get under the bucket or lift arms or reach through the lift arms when the loader is raised.

Do not leave the tractor-loader when it is in motion.

Always shut off the engine when leaving the tractor.

Do not tow the tractor faster than 20 mph.

When parking, make sure the brake pawls are set or the Select-O-Speed transmission is in "park" position.

Place adequate counterweight on the rear of the tractor so that the unit is stable.

Exercise extreme caution when operating the tractor with a raised, loaded bucket or fork.

The Tractor and Implement Division of the Ford Motor Company, being a member of the National Safety Council, is privileged to use the Green Cross to denote safety instructions in operators manuals.

# ATTACHMENTS

8. As you approach the truck, raise the loader bucket to clear the body.
9. At the proper moment, depress the inching pedal and shift to reverse.
10. Hit the brakes to stop forward travel, dump the bucket, and release the inching pedal to back away from the truck. While backing away, retract and lower the bucket simultaneously, so that the bucket hits the ground in a level position when you change direction to proceed to the pile.

Continued use and practice of these procedures will enable operator's to achieve smooth, fast, and efficient loader performance.

## LOADER ATTACHMENTS

A variety of attachments, especially designed for industrial operations, are available for use on the Ford Industrial Loader. These attachments, sold separately by your Ford Tractor-Equipment Dealer, are shown in Figures 3 and 4.

- 19-98 Stockpile Bucket: 12 Cu. Ft.
- 19-99 Light Material Bucket: 3/4 Cu. Yd.
- 19-217 Material Bucket: 11 Cu. Ft.
- 19-333 Material Bucket: 1/2 Cu. Yd.

Ford buckets have several construction features that make them outstanding. Note the following features, then order the bucket (or buckets) you need through your Ford Tractor-Equipment Dealer.

- The backs of the buckets are curved for easier filling.
- The tops are reinforced for greater strength.
- The bottoms are reinforced and equipped with 3/8" wear straps for longer life.
- The tops have spill guards to protect the operator when the bucket is raised for high loading operations.

**NOTE:** Do not attempt to handle bucket loads in excess of the loader capacity.

**114541 Bucket Tooth:** The installation of bucket teeth, Figure 4, increases digging action in hard ground. Six or nine teeth may be installed, depending on the size of the bucket.

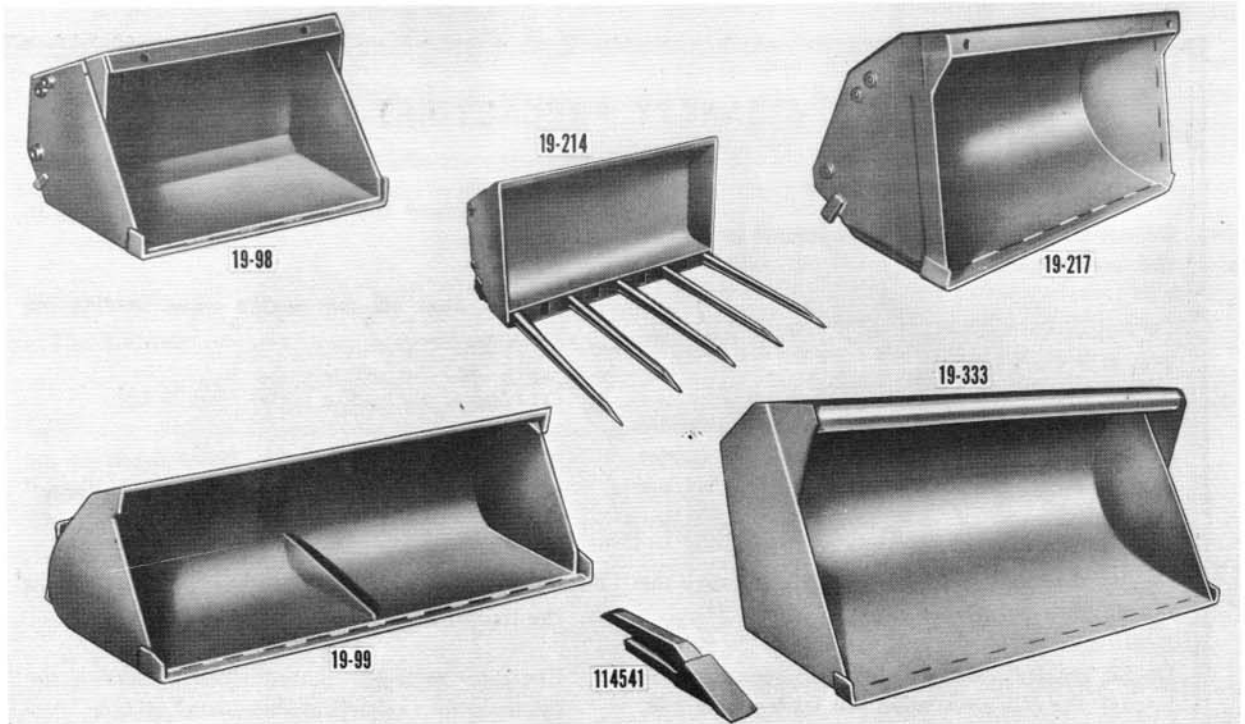

Figure 3  
Loader Attachments

# ATTACHMENTS

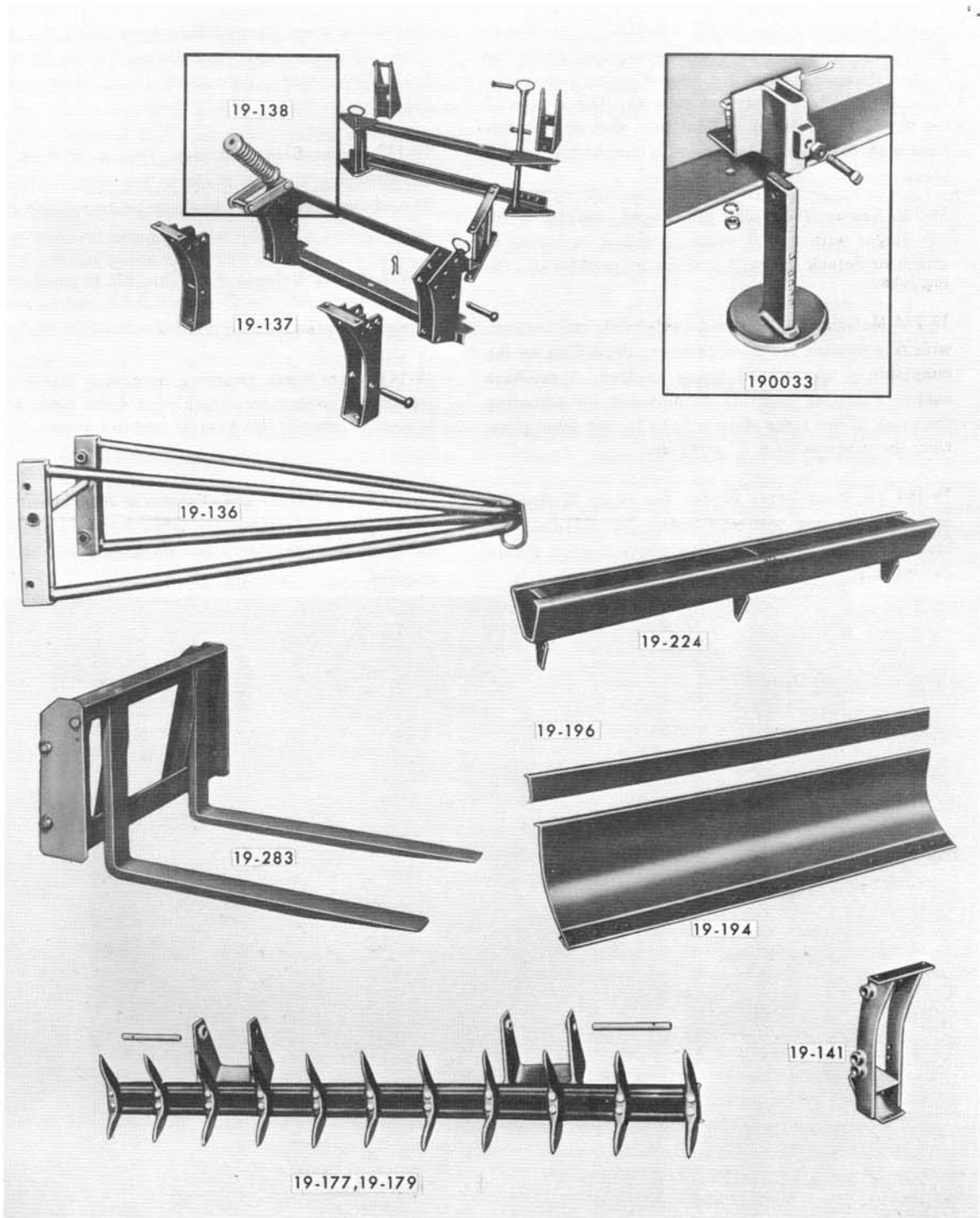

Figure 4  
Loader Attachments

## ATTACHMENTS

**Bucket Scarifier:** The 19-177 Scarifier is used with the 19-333 bucket. The scarifier is attached to the loader lift arms, behind the bucket, to rip hard-packed material when moving in reverse. The design of the scarifier permits it to float free when moving forward and does not interfere with the normal loader operation.

**19-136 Crane:** The crane attachment provides a 16' lift height with a 64" reach. It's fast and easy to attach or detach and will perform any number of lifting jobs.

**19-214 Material Fork:** The material fork can be used with five to nine replaceable tines, depending on the consistency of material being handled. A two-hole bucket mounting position is provided for adjusting the pitch of the tines. One hole is for the level position; the other is for a 2" pitch-up.

**19-194 Six Foot Dozer Blade:** The dozer blades are available for use with the Series 725 Loader. The blade cutting edge is reversible, providing two usable cutting edges.

**19-196 Six Foot Dozer Blade Extension:** The dozer blade extension adds five inches in height to the basic dozer blade, increasing its material handling capacity.

**19-137 Dozer Blade Adapter:** This adapter is used for attaching a dozer blade to the loader lift arms. The adapter permits the blade to be angled and pitched.

**19-138 Spring Release Kit:** This kit is used on the 19-137 Angle Adapter to absorb shock and to provide a release mechanism for the dozer blade.

**19-141 Dozer Blade Mounting Brackets:** This bracket provides a method for attaching a dozer blade to the loader lift arms in the straight position only.

**19-224 Blade Weight Box-Extension Attachment:** The blade weight box-extension adds 5 inches height to the blade and provides a box for adding weight when required.

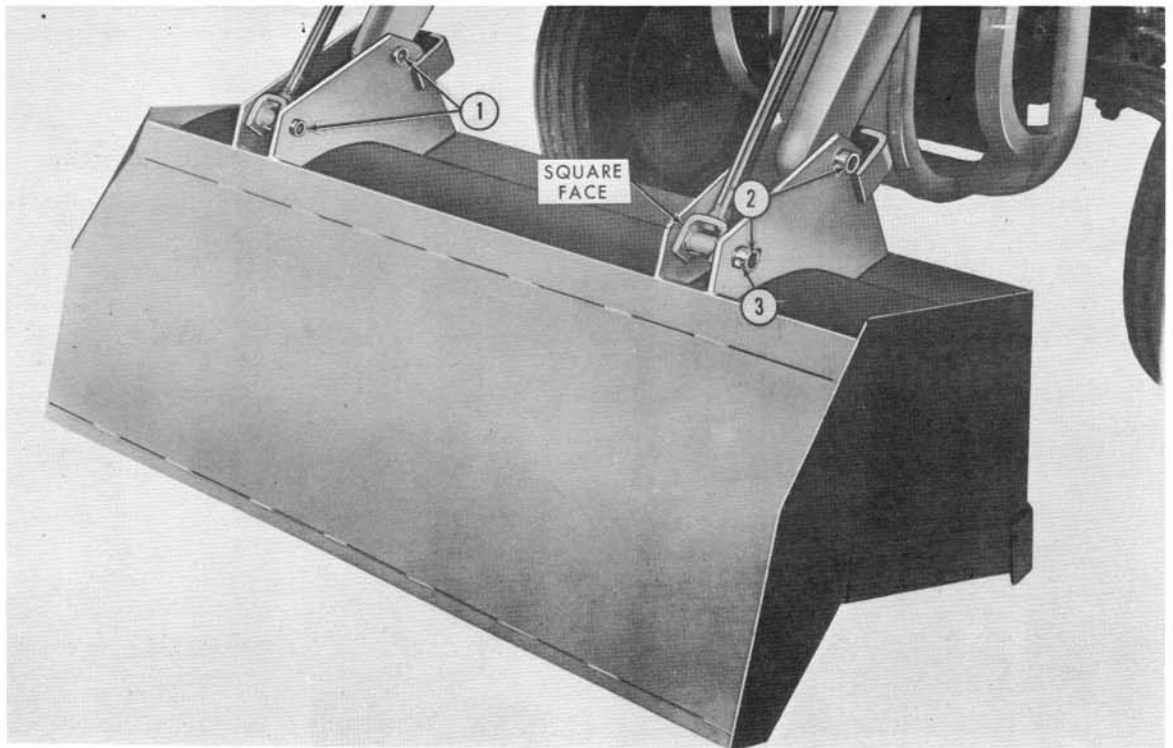

Figure 5  
Attaching Bucket

## MAINTENANCE

**19-179 Blade Scarifier:** The scarifier is attached to the loader lift arms, behind the six foot blade, to rip hard-packed material when moving in reverse. The design of the scarifier permits it to float free when moving forward and does not interfere with the normal blade operation.

**Mushroom Skid Shoes, Part No. 190033:** Skid shoes are used to support dozer blades for clearing snow and similar operations. The shoes maintain surface clearance and prevent "digging-in".

**19-283 Fork Lift Attachment:** This attachment is designed for lifting pallets, logs, bails, and other similar bulky materials. Its maximum lift capacity is 1000 lbs. The tines are adjustable from a width of 8-3/4" to 37". The fork lift attachment will also fit on the standard Category I tractor three-point linkage.

### BUCKET INSTALLATION

1. Position the bucket, lift arms, and cylinder rods as shown in Figure 5.

2. Install the 1" x 6" bucket attaching pins as shown at (2) and (3). Secure each pin with a 3/8" x 2-1/2" grade 5 hex head bolt and self-locking nut (1).

**NOTE:** The square face of the cylinder rod end must be forward as shown in Figure 5. The longer portion extends toward the lift arm and provides a bucket stop when the bucket cylinder is retracted.

### LUBRICATION

There are ten lubrication fittings on the Series 725 Loader. Figure 6 shows five of the fitting locations on the right side of the loader. The other five are on the left side in the same location. Lubricate the loader through these fittings after every eight hours of operation. Use a sufficient quantity of grease to force out the old dirt-encrusted grease.

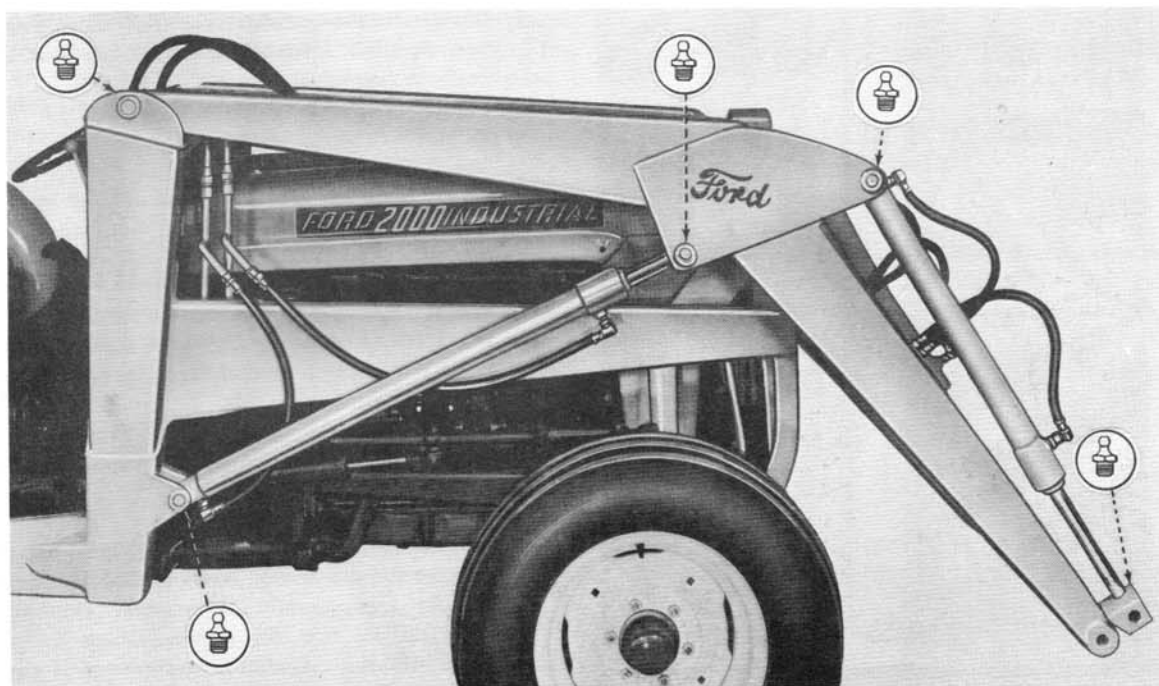

Figure 6  
Lubrication Chart

## HYDRAULIC SYSTEM MAINTENANCE

1. Check the fluid level in the hydraulic system daily. Maintain the level 13-1/2" from the top of the filler opening. See Figure 7.

**NOTE:** The fluid level should be measured with all cylinders retracted.

2. Repair hydraulic fluid leaks promptly to avoid loss of fluid and damage to the system.
3. Replace hoses immediately when they are found to be leaking, severely damaged by a cut or scrape, or extended at the fitting.
4. After the first 50 hours of operation and every 300 hours thereafter, the hydraulic oil and filter should be replaced as outlined below.

**IMPORTANT:** The 300 hour service interval is based on normal operating conditions. Your particular operation may require servicing the oil and filter more often.

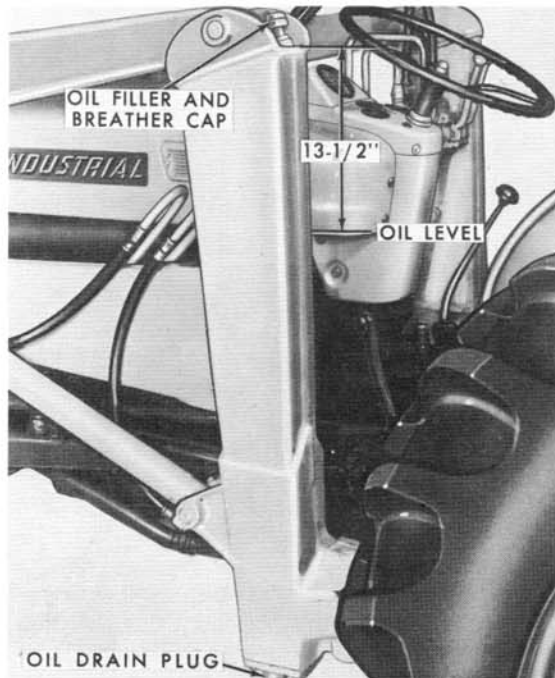

Figure 7  
Oil Filler and Breather Cap

## Changing Hydraulic Oil and Filter

1. Warm the oil by operating the loader, and place a drain pan under the left lift post. Remove the oil drain plug, Figure 7, from the bottom of the post. Allow the oil to drain.
2. Loosen the lower hose clamp on the filter base tube.
3. Remove the four filter attaching bolts from the bottom of the lift post and remove the filter assembly.
4. Remove the filter attaching bolt and bypass adapter shown in Figure 8. Discard the oil filter element and gasket.
5. Flush the reservoir, in the area of the filter, to remove any foreign material that may have accumulated.
6. Clean the filter base and bypass adapter. Install a new filter element on the base and secure with the bypass adapter and attaching bolt. Torque the bolt to 50-55 inch lbs.
7. Position a new gasket on the filter base. Position the filter assembly in the lift post and install the four attaching bolts.

**IMPORTANT:** Be sure the gasket is in place.

8. Attach the filter base tube hose and tighten the clamp. Secure the connection so that there is no air leaks or oil leaks.
9. Fill the hydraulic system with Ford Specification M2C41 Hydraulic Oil. The correct oil level is 13-1/2" from the top of the filler opening as shown in Figure 6.

**NOTE:** The total hydraulic system capacity is 9 gallons.

10. Operate the tractor at 1200 to 1500 rpm and actuate the lift and bucket levers (no load in bucket), for approximately 15 minutes. This will bleed the air from the system. Check the oil level with the cylinders retracted and if necessary, add more oil.

## STORAGE

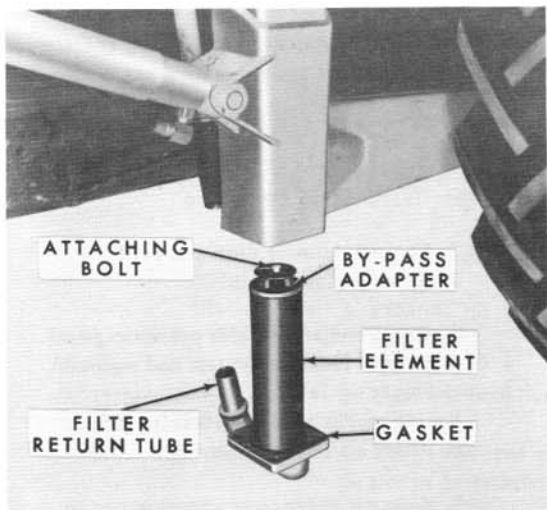

Figure 8  
Oil Filter Removed

An Inlet Hose Reinforcement Spring, Part No. 290991 is available from your Ford Tractor-Equipment Dealer. One Spring installed in each inlet tube hose will reduce the possibility of hose collapsing, which may result during cold weather operation.

Also available is a pressure cap for use in place of the original breather cap. The pressure cap is desirable for cold weather operation or when operating in dusty conditions. For further information, contact your Ford Tractor-Equipment Dealer.

## STORAGE

Always store the loader in a clean, dry place when possible. Coat the exposed parts of the control valve spools and cylinder rods with a rust preventative.

The loader may be removed from the tractor as follows:

1. Remove the drain plug from the bottom of the left lift post and allow the oil to drain. Reinstall the drain plug.
2. Remove the two hydraulic lines from the front pump. Remove the pump and drive shaft.
3. Cap the ends of the hydraulic tubes and the pump opening to prevent dirt from entering the hydraulic system.
4. Disconnect the headlight wires.
5. Support the weight of the loader with a chain fall or other suitable hoist.
6. Remove the nuts and lock washers from the fender bolts. Remove the two 1" x 4-1/2" bolts and lock nuts that attach the loader frame to the front support plate.
7. Raise the loader frame to provide clearance between the tractor axle and the frame. Back the tractor away and lower the loader.
8. Install the lock washers and nuts on the fender bolts.
9. Remove the headlights from the loader frame and install them on the tractor in their original position.
10. Remove the pump mounting bracket from the front of the tractor if there is a possibility that it may be bumped. A bent pump mount will cause pump shaft misalignment.

# TROUBLE SHOOTING

The following material on trouble shooting is presented to aid the operator in quickly recognizing operational problems, and serve as a guide for the dealer in diagnosing their general cause and corrective action.

## LOADER

<i>Problem</i>	<i>Possible Cause</i>	<i>Correction</i>
Slow or erratic rate of lift.	<ol style="list-style-type: none"> <li>1. Low pump efficiency.</li> <li>2. Valve spools not properly centered.</li> <li>3. Relief pressure too low.</li> <li>4. Low fluid level.</li> <li>5. Foaming fluid.</li> <li>6. Air in hydraulic lines and cylinders.</li> <li>7. Cold oil.</li> <li>8. Restriction in system.</li> </ol>	<ol style="list-style-type: none"> <li>1. Replace worn or damaged parts.</li> <li>2. Adjust valve spools.</li> <li>3. Check and adjust with pressure gauge.</li> <li>4. Correct leaks in system and maintain proper oil level.</li> <li>5. Use proper type of hydraulic fluid.</li> <li>6. Bleed air from system.</li> <li>7. Warm oil and/or use pressure cap in place of breather.</li> <li>8. Check hydraulic line from reservoir to pump.</li> </ol>
Bucket drops under load.	<ol style="list-style-type: none"> <li>1. Piston packing cut, worn or loose.</li> <li>2. Cylinder bore not smooth.</li> <li>3. Excessive amount of fluid by-passing at control valve spool.</li> <li>4. Bucket cylinder shaft "O" ring damage.</li> <li>5. Piston packing improperly installed.</li> </ol>	<ol style="list-style-type: none"> <li>1. Replace and install properly.</li> <li>2. Replace cylinder.</li> <li>3. Replace valve.</li> <li>4. Disassemble piston assembly and replace "O" ring on shaft. Check "O" ring groove and spacer for burrs.</li> <li>5. Install correctly.</li> </ol>
Lift arms drop under load.	<ol style="list-style-type: none"> <li>1. Check valve worn or not seating properly.</li> <li>2. Piston packing cut, worn or loose.</li> <li>3. Lift cylinder shaft "O" ring damage.</li> <li>4. Excessive amount of fluid by-passing at spool.</li> <li>5. Cylinder bore not smooth.</li> <li>6. Piston packing improperly installed.</li> </ol>	<ol style="list-style-type: none"> <li>1. Inspect parts, replace defective parts.</li> <li>2. Replace and install properly.</li> <li>3. Disassemble piston assembly and replace "O" ring on shaft. Check "O" ring groove and spacer for burrs.</li> <li>4. Replace control valve.</li> <li>5. Replace cylinder.</li> <li>6. Assemble correctly.</li> </ol>
Low lift capacity.	<ol style="list-style-type: none"> <li>1. Low pump efficiency.</li> <li>2. Relief pressure too low.</li> <li>3. Piston packing cut, worn or loose.</li> <li>4. Valve spools by-pass oil.</li> </ol>	<ol style="list-style-type: none"> <li>1. Replace worn or damaged parts.</li> <li>2. Check and adjust with pressure gauge.</li> <li>3. Replace and install properly.</li> <li>4. Replace valve.</li> </ol>



# TROUBLE SHOOTING

<i>Problem</i>	<i>Possible Cause</i>	<i>Correction</i>
Drive shaft failure.	<ol style="list-style-type: none"> <li>1. Partial spline engagement.</li> <li>2. Tractor front axle support failure.</li> <li>3. Misalignment.</li> <li>4. Improper assembly.</li> <li>5. Flexible joint improperly spaced.</li> </ol>	<ol style="list-style-type: none"> <li>1. Adjust for full spline engagement in hub.</li> <li>2. Repair or replace.</li> <li>3. Check installation of hub and pump mounting bracket.</li> <li>4. Check for correct bolt attaching pulley hub to crankshaft.</li> <li>5. Use spacers as required.</li> </ol>
Oil Filter malfunction.	<ol style="list-style-type: none"> <li>1. Damaged from overtightening.</li> <li>2. Cut or damaged gasket.</li> <li>3. Loose installation.</li> <li>4. Dirty filter causing by-passing.</li> </ol>	<ol style="list-style-type: none"> <li>1. Replace filter element and torque to 50–55 in. lbs.</li> <li>2. Replace filter gasket.</li> <li>3. Tighten properly. Torque to 50–55 in. lbs.</li> <li>4. Clean filter.</li> </ol>

## HYDRAULIC OIL LEAKAGE

Cylinder "O" rings.	<ol style="list-style-type: none"> <li>1. Cut in installation.</li> <li>2. Rough or burred cylinder chamfer.</li> <li>3. Extrusion from excessive clearance.</li> </ol>	<ol style="list-style-type: none"> <li>1. Replace "O" rings.</li> <li>2. Remove sharp edges with crocus cloth and replace ring.</li> <li>3. Replace tube or stuffing box.</li> </ol>
Cylinder packings.	<ol style="list-style-type: none"> <li>1. Worn packing lip.</li> <li>2. Damaged in assembly.</li> <li>3. Cut by a burr or scored rod.</li> <li>4. "V" chevrons assembled backwards.</li> </ol>	<ol style="list-style-type: none"> <li>1. Replace packing.</li> <li>2. Replace packing.</li> <li>3. Remove burr or replace rod.</li> <li>4. Install correctly.</li> </ol>
Pump seals.	<ol style="list-style-type: none"> <li>1. Shaft burred or scored.</li> <li>2. Worn seals.</li> <li>3. Abrasives in system.</li> </ol>	<ol style="list-style-type: none"> <li>1. Replace shaft and seal.</li> <li>2. Replace seal.</li> <li>3. Change oil, oil filter, and flush system.</li> </ol>
Valve seals.	<ol style="list-style-type: none"> <li>1. Paint ring on spool.</li> <li>2. Score or rough finish on spool.</li> <li>3. "O" ring leaking between valve and mounting plate.</li> <li>4. Spool "O" ring damage.</li> </ol>	<ol style="list-style-type: none"> <li>1. Remove paint and replace seals.</li> <li>2. If feasible, smooth with crocus cloth, or replace valve.</li> <li>3. Replace "O" ring and tighten nuts evenly.</li> <li>4. Replace "O" ring seals.</li> </ol>

## PUMP

Body, and/or pressure plate scored or scratched.	<ol style="list-style-type: none"> <li>1. Abrasives or dirt in system.</li> </ol>	<ol style="list-style-type: none"> <li>1. Change oil, oil filter, and flush system.</li> </ol>
Pump burst.	<ol style="list-style-type: none"> <li>1. High pressure.</li> <li>2. Obstruction in line.</li> </ol>	<ol style="list-style-type: none"> <li>1. Check relief valve with pressure gauge and adjust.</li> <li>2. Check hose and line for obstruction.</li> </ol>

# TROUBLE SHOOTING

<i>Problem</i>	<i>Possible Cause</i>	<i>Correction</i>
Pump diaphragm gasket broken.	<ol style="list-style-type: none"> <li>1. Cavitation.</li> <li>2. Excessive pressure.</li> </ol>	<ol style="list-style-type: none"> <li>1. Check fluid level—type of hydraulic fluid. Check for leaks at pump intake.</li> <li>2. Check valve and adjust with pressure gauge.</li> </ol>
Premature bearing failure.	<ol style="list-style-type: none"> <li>1. Drive shaft misalignment.</li> <li>2. Flexible coupling worn.</li> </ol>	<ol style="list-style-type: none"> <li>1. Replace housing. Align shaft.</li> <li>2. Replace coupling.</li> </ol>
Pump and/or valve noisy.	<ol style="list-style-type: none"> <li>1. Cavitation caused by low fluid level.</li> <li>2. Foaming fluid.</li> <li>3. Pump shaft seal leaks.</li> <li>4. Intake hose leaks.</li> <li>5. Intake hose or fittings loose.</li> <li>6. Intake hose collapsed.</li> <li>7. Worn pump.</li> <li>8. Relief valve pressure too high.</li> <li>9. Breather very dirty.</li> <li>10. Fluid too heavy.</li> <li>11. Water in oil.</li> <li>12. Ambient temperature too cold.</li> <li>13. Mismatch of pump gears.</li> </ol>	<ol style="list-style-type: none"> <li>1. Correct leaks in system and maintain full reservoir.</li> <li>2. Use proper type of hydraulic fluid.</li> <li>3. Replace seals.</li> <li>4. Replace hose.</li> <li>5. Tighten clamps and use sealer on fittings.</li> <li>6. Install reinforcing spring inside hose.</li> <li>7. Replace necessary parts.</li> <li>8. Check and adjust using pressure gauge.</li> <li>9. Remove and rinse clean.</li> <li>10. Use proper type fluid and/or warm oil.</li> <li>11. Replace with fresh M2C41 oil.</li> <li>12. Use pressure cap instead of breather.</li> <li>13. Use matched gear set.</li> </ol>

## VALVE

Levers stick.	<ol style="list-style-type: none"> <li>1. Valve spool binds due to scoring or broken centering spring.</li> <li>2. Linkage binding.</li> <li>3. Valve spools warped.</li> </ol>	<ol style="list-style-type: none"> <li>1. Disassemble and inspect for dirt or scoring. Check spool and centering spring. Install in same valve body hole.</li> <li>2. Inspect linkage.</li> <li>3. Determine cause for extreme heat condition.</li> </ol>
Bypass fluid in neutral.	<ol style="list-style-type: none"> <li>1. Spools pitted by corrosion.</li> <li>2. Spools scored.</li> <li>3. Bores damaged.</li> </ol>	<ol style="list-style-type: none"> <li>1. Replace valve.</li> <li>2. Replace valve.</li> <li>3. Replace valve.</li> </ol>
Relief valve does not hold pressure.	<ol style="list-style-type: none"> <li>1. Relief valve "O" ring not sealing.</li> <li>2. Foreign object holds valve open.</li> <li>3. Pressure setting too low.</li> <li>4. Burred or scored relief valve ball, seat or seal.</li> <li>5. Broken relief spring.</li> </ol>	<ol style="list-style-type: none"> <li>1. Replace "O" rings.</li> <li>2. Disassemble valve and clean.</li> <li>3. Check pressure with gauge and adjust with shims.</li> <li>4. Replace ball or assembly.</li> <li>5. Replace spring.</li> </ol>

# SPECIFICATIONS

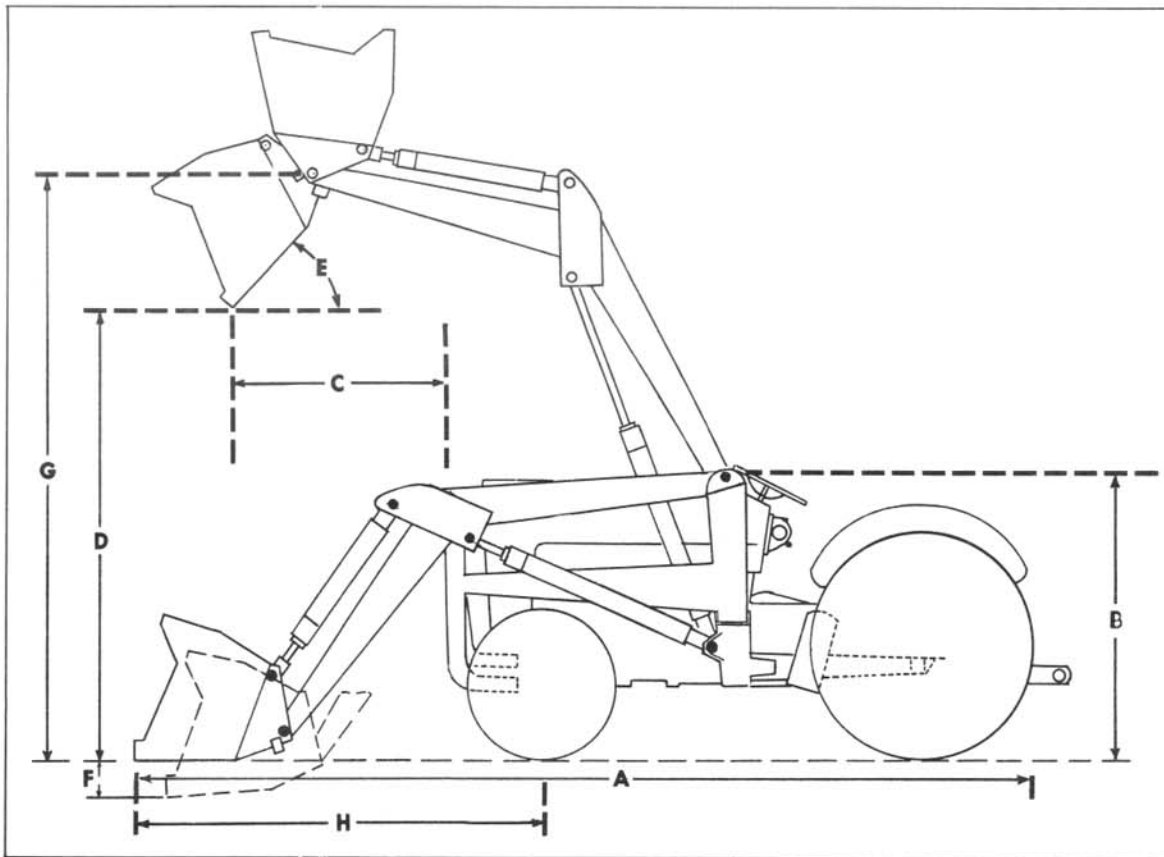

Figure 9  
Specifications

A.....	13'10-1/2"
B.....	4'9"
C.....	19-1/2" at 43°
D.....	8'6" at 43°
E.....	43°
F.....	4"
G.....	10'4-3/8"
H.....	66-1/2"
Approx. Shipping Weight .....	1000 lbs.

The above dimensions are based on a Ford Series 4000 All-Purpose Tractor equipped with 13.6-28 rear tires, 6:50-16 front tires, and a 19-333 material bucket.

*"Ford Motor Company, whose policy is one of continuous improvement, reserves the right to make changes in design and specifications at any time without notice and without obligation to modify units previously built."*

# SPECIFICATIONS

## PERFORMANCE

BREAKAWAY CAPACITY.....	2590 lbs.	SPEED OF LIFT (Full Load).....	4.5 Secs.
LIFT CAPACITY-FULL HEIGHT.....	1600 lbs.	SPEED OF DROP (No Load).....	2.2 Secs.

## BUCKET OPERATION

BUCKET DUMP.....	2 Secs.	BUCKET ROLL BACK AT GROUND LEVEL....	23°
BUCKET DUMP ANGLE AT FULL LIFT.....	43°		

## HYDRAULIC SYSTEM

RELIEF PRESSURE.....	1600 psi
OIL CAPACITY.....	9 gals.

Main frame is reservoir with filler boss and breather on top of left lift post.

### RESERVOIR:

Type.....	Main frame structure
Location.....	Horizontal members of front of frame and L.H. lift post.

### PUMP

Type.....	Gear type with instant response and high volume.
Capacity At 2200 rpm.....	15.5 at 1600 psi
Mounting.....	Direct to front mounting bracket; not on loader frame.

Drive.....	Splined drive shaft with flexible coupling to protect the pump from shock loads.
------------	--

### CONTROL VALVE (Component 19-335):

Type .Double spool, open center, with 3 position spools to control lift cylinders and 3 position spools to control tilt cylinders. Spring-loaded spools for self-centering in neutral position. Anti-cavitation check for tilt cylinders.

Flow Capacity.....	20 gpm
--------------------	--------

### CONTROL VALVE (Component 19-336):

Type..... Same as component 19-335 except with 2 positions to control single acting lift cylinders.

OIL SPECIFICATION...Ford Specification M-2C-41

OIL FILTER..... Full flow - Throw-away type

### LIFT CYLINDERS:

Type (Comp. 19-335)...Double Acting with ground and polished cylinder rod, chromium plated. Cylinder of seamless tubing. Cylinder has fabricated V-ring packing and a neoprene wiper ring.

Type (Comp. 19-336)...Single Acting with ground and polished cylinder rod, chromium plated. Cylinder tube is standard seamless pipe. Cylinder head has fabricated V-ring packing and a neoprene wiper ring.

Number (Comp. 19-335).....	2 Double Acting
Number (Comp. 19-336).....	2 Single Acting
Extended Length.....	.76''
Retracted Length.....	42-11/16''
Stroke.....	33-21/64''
Piston Diameter.....	2''
Rod Diameter (Comp. 19-335).....	1-1/2''
Rod Diameter (Comp. 19-336).....	2''

### BUCKET CYLINDERS:

Type..... Double acting with chromium plated cylinder rods, turned, ground and polished. V-ring packings and a neoprene wiper ring.

Extended Length.....	51-3/8''
Retracted Length.....	31-5/16''
Stroke.....	20''
Piston Diameter.....	2''
Rod Diameter.....	1-1/4''

# HEADQUARTERS for

# QUALITY SERVICE

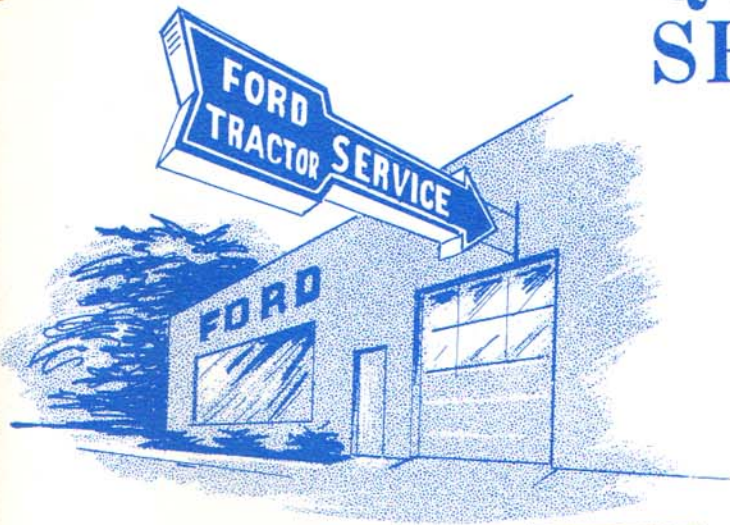

**AND**

**For the Finest Service—In  
the Shop or On the Job:—**

- **Factory Trained Servicemen—  
Who Know Your Equipment**
- **Factory Approved Methods—  
To Keep You "On the Go"  
Longer**
- **Factory Approved Tools and  
Equipment—  
To Do the Best Job Quicker**

**For Dependable—Genuine Ford  
Tractor and Equipment Parts:**

- **Designed and Field-Tested  
by Skilled Engineers**
- **Made of High Quality Materials  
by Precision Manufacturing  
Methods**
- **Fully Warranted by Your  
Dealer**

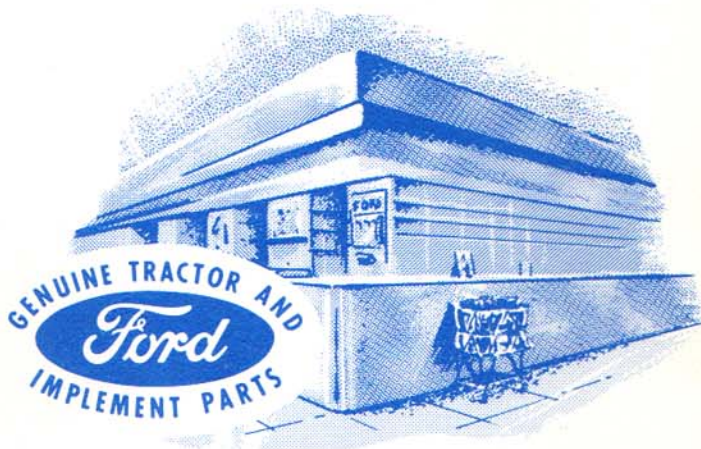

*whatever your service needs...  
whatever your parts or accessories  
requirements...your **Ford Tractor  
and Equipment Dealer** is equipped  
to serve you better...for less!!!*

A PRODUCT OF



MOTOR COMPANY

TRACTOR AND IMPLEMENT OPERATIONS (U.S.)  
BIRMINGHAM, MICHIGAN

FORD MOTOR CO.

SE 0 8839 5636

PRINTED IN U.S.A.